

**WARNING:** Bikes or rack falling in road can cause serious accidents resulting in bodily injury—do not use rack on any vehicle on which it can not be properly mounted as described in this instruction sheet.

- Top hooks must be completely hooked over solid metal edges at top/ front of trunk lid or rear door—never hook to rain gutters, roof racks, vertical glass, rubber or plastic moldings.
- Mount rack only with bottom feet on a rigid surface of car (never on glass), and with bottom foot assembly completely extended. Never use rack on trailers or on the front of vehicles.
- Never carry more than 2 bicycles (**MAX CAPACITY: 70 LB**) - no tandems, mopeds, or recumbents. Car tail lights must remain visible. Bikes must be securely tied to rack. Use bike tie-downs, or additional straps if necessary.
- Drive conservatively, especially over bumps. Never use off-road.
- Do not use if any part of the rack is damaged, worn, or missing. Contact R. A. Allen Co., Inc. for replacement parts.

**CAUTION:** Use Allen 102S only in accordance with local motor vehicle and traffic regulations.

- To avoid damage to rear door or trunk, do not open trunk or rear door when hooks or rack are in place.
- Install rack and load bicycles only at a safe distance away from moving traffic.
- Only rubber feet and rack should come into contact with car.
- Make sure that all of rack and bicycles are kept at a safe distance from road and hot exhaust.
- Remove rack from car when not in use

### A. SETTING UP RACK:

NOTE: DRAWING BELOW SHOWS MODEL 103S

#### 1. FOLD OUT TOP FOOT/ CARRY-ARM ASSEMBLY.

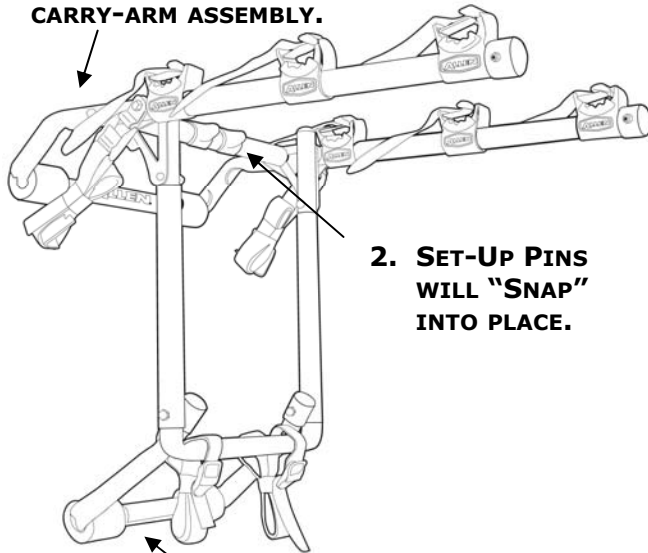

#### 2. SET-UP PINS WILL "SNAP" INTO PLACE.

#### 3. COMPLETELY FOLD OUT BOTTOM FOOT ASSEMBLY.

### B. BEFORE INSTALLING RACK:

1. MAKE SURE THAT CONTACT SURFACES BETWEEN CAR AND RUBBER FEET ARE THOROUGHLY CLEAN AND FREE OF DIRT, AND THAT ALL RUBBER FEET ARE PROPERLY SPACED.

2. MAKE SURE THAT TOP BUCKLES ARE THREADED AS SHOWN ON RIGHT.

3. INSPECT ALL STRAPS TO MAKE SURE THAT THEY ARE NOT WORN OR DAMAGED IN ANY

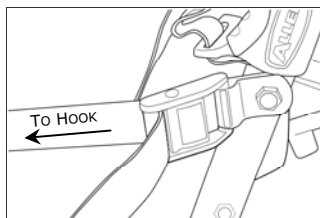

### C. INSTALLING RACK ON VEHICLE:

1. TOP HOOKS MUST BE COMPLETELY HOOKED OVER METAL EDGES AT TOP OF TRUNK, REAR DOOR, OR HATCHBACK. NEVER HOOK TO RAIN GUTTERS, ROOF RACKS, VERTICAL GLASS OR PLASTIC MOLDINGS. OPEN TRUNK/ HATCH SLIGHTLY FOR EASIEST ATTACHMENT OF HOOKS. **BE CAREFUL THAT HOOKS DO NOT BIND WHEN TRUNK/ HATCH IS OPENED. BINDING HOOKS WILL DAMAGE VEHICLE.**

**SECURING TOP HOOKS ON VEHICLES WITHOUT ADEQUATE CLEARANCE AT THE TOP EDGE OF REAR TRUNK/ HATCH:** UNTHREAD TOP STRAPS FROM METAL BUCKLES AND OPEN REAR TRUNK/ HATCH. PLACE TOP HOOKS INSIDE OF VEHICLE (JUST INSIDE OF TOP EDGE OF REAR TRUNK/ HATCH). **CAREFULLY** CLOSE REAR TRUNK/ HATCH ON TOP STRAPS, MAKING CERTAIN HOOKS DO NOT BIND BETWEEN FRAME AND REAR DOOR.

**IMPORTANT:** WITH REAR DOOR CLOSED, PULL TOP STRAPS TO BRING HOOKS TIGHT AGAINST INSIDE OF VEHICLE. RE-THREAD TOP STRAPS AS SHOWN IN **SECTION B.** MOUNT RACK TO VEHICLE.

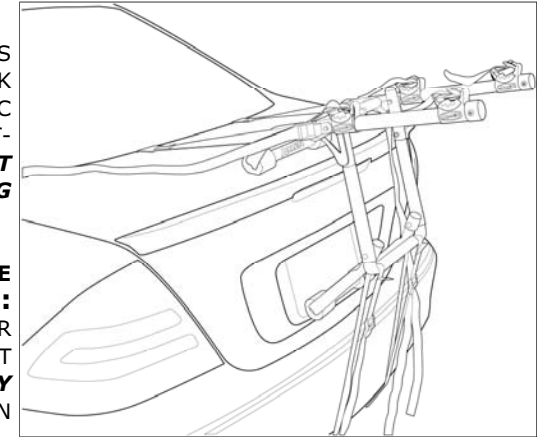

2. SET LENGTH OF TOP STRAPS TO POSITION RACK WITH ITS CARRY ARMS INCLINED SLIGHTLY UPWARDS, AND HIGH ENOUGH TO KEEP BIKES AWAY FROM ROAD AND EXHAUST.
3. ONCE THE LENGTH OF THE TOP STRAPS ARE SET, THE BOTTOM FOOT ASSEMBLY SHOULD BE HELD AGAINST THE VEHICLE IN ITS COMPLETELY OPEN POSITION. IT IS IMPORTANT THAT THE BOTTOM GRAY RUBBER PADS ARE INSTALLED ON THE VEHICLE IN A LOCATION WHERE THERE IS PROPER SUPPORT. THE BOTTOM FEET SHOULD NEVER BE INSTALLED ON GLASS.

4. MAKE SURE THAT THE BOTTOM STRAPS ARE PROPERLY THREADED THROUGH PLASTIC BUCKLES.

5. COMPLETELY HOOK BOTTOM HOOKS TO A METAL EDGE BELOW BUMPER, OR AT THE BOTTOM OF THE TRUNK/ REAR DOOR. *IF THERE IS NO METAL EDGE BELOW BUMPER, SEE ALTERNATE METHOD FOR BOTTOM HOOK ATTACHMENT ON THE NEXT PAGE.*

6. COMPLETELY TIGHTEN BOTTOM STRAPS BY PULLING ON FREE END OF STRAPS UNTIL ELASTIC PORTION OF STRAPS ARE COMPLETELY STRETCHED.

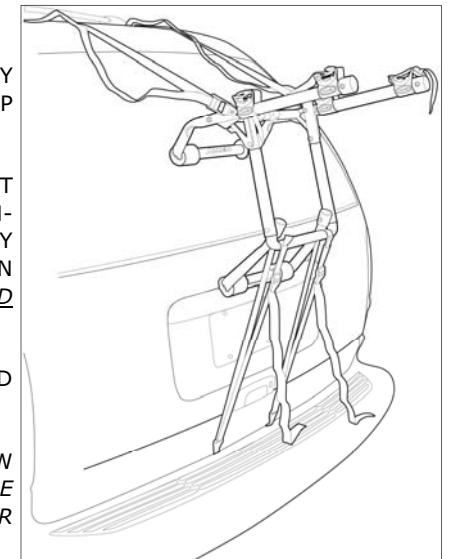

### D. ALTERNATE METHOD #1 FOR BOTTOM STRAP:

USE IF THERE IS NO METAL EDGE BELOW BUMPER FOR ATTACHMENT OF HOOKS

- REMOVE BOTTOM STRAPS FROM BOTTOM HORIZONTAL CROSS-BAR, AND LOOP BOTTOM STRAP AROUND CARRY-ARMS NEAR TOP METAL BUCKLES. ATTACH HOOKS TO LOWER EDGE OF TRUNK/ REAR HATCH. TIGHTEN BOTTOM STRAPS.

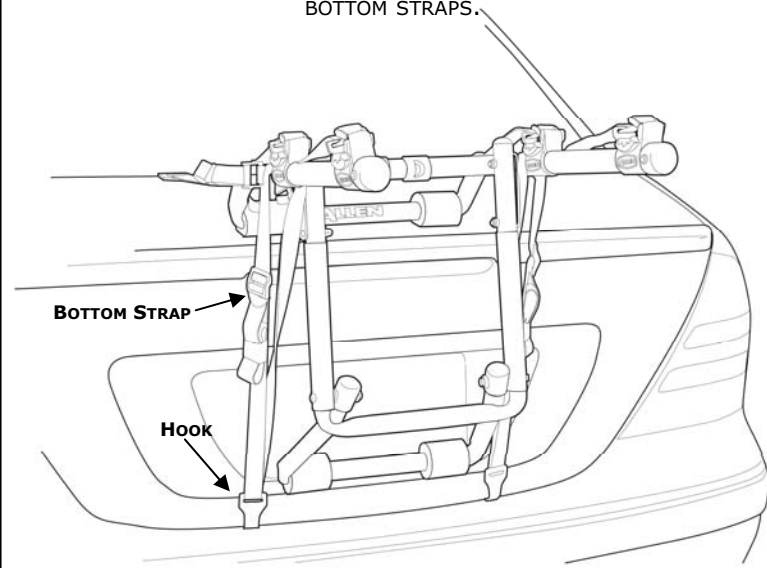

### E. ALTERNATE METHOD #2 FOR BOTTOM STRAP:

USE IF THERE IS NO METAL EDGE BELOW BUMPER OR ON TRUNK FOR ATTACHMENT OF HOOKS

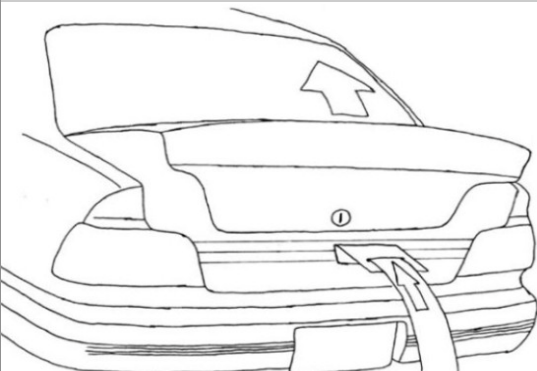

- BEFORE INSTALLING RACK ON VEHICLE, REMOVE BOTTOM STRAPS OPEN TRUNK SLIGHTLY AND PLACE BOTTOM HOOKS JUST INSIDE OF TRUNK/ HATCH. CAREFULLY CLOSE TRUNK ON BOTTOM STRAP. PULL STRAPS TO BRING HOOKS AGAINST THE INSIDE

OF TRUNK. MOUNT RACK ONTO CAR AS DESCRIBED IN SECTION C. RETHREAD BOTTOM STRAPS AND TIGHTEN.

### F. LOADING BICYCLES ON RACK:

1. REMOVE ALL LOOSE ITEMS FROM BICYCLES (PUMPS, BAGS, ETC.), AND CHECK THAT ALL QUICK RELEASE HUBS ARE TIGHT.
2. LOAD FIRST BICYCLE WITH ITS CHAIN AND GEARS FACING AWAY FROM RACK. MAKE SURE THAT BICYCLES DO NOT COME IN CONTACT WITH VEHICLE.
3. LOAD SUBSEQUENT BICYCLES IN ALTERNATING DIRECTIONS. FOR BEST WEIGHT DISTRIBUTION, LOAD HEAVIEST BICYCLES FIRST, WITH LIGHTER BICYCLES ON THE OUTSIDE. ADD PADDING BETWEEN BICYCLE CONTACT POINTS, IF NECESSARY.
4. AFTER BICYCLES ARE LOADED, CHECK THAT ENTIRE RACK IS SECURE AND THAT NO-WOBBLE BOLT IS TIGHT, AND THAT THE RACK IS STILL FIRMLY IN PLACE. VISION OUT OF REAR WINDOW MAY BE RESTRICTED—USE SIDE MIRRORS ACCORDINGLY WHEN BACKING UP.

#### **SPECIAL NOTE ON INSTALLING WOMEN'S STYLE FRAMES:**

PLACE ONE CARRY ARM UNDER FRONT TOP TUBE. WITH THE OTHER CARRY ARM, ROTATE TIE-DOWN CRADLE, AND PLACE CARRY IN SPACE BEHIND SEAT TUBE AND BELOW REAR DOWN-STAY. THE **ALLEN 900B ADAPTOR BAR** IS ALSO RECOMMENDED FOR THIS APPLICATION.

### G. SECURING BIKES TO RACK:

ALL BIKES MUST BE SECURELY TIED TO RACK. USE INDIVIDUAL TIE-DOWN STRAPS, OR ADDITIONAL STRAPS IF NECESSARY.

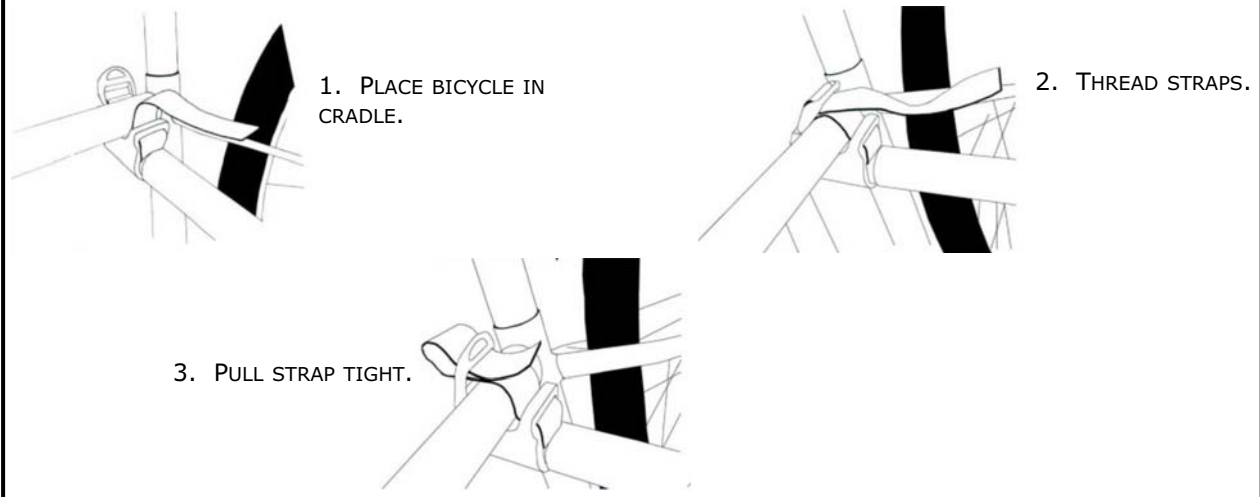

#### **ALLEN LIFETIME WARRANTY:**

IF AN ALLEN BIKE RACK IS FOUND TO HAVE A DEFECT IN WORKMANSHIP OR MATERIAL OVER THE LIFETIME OF THE ORIGINAL PURCHASER, ALLEN WILL REPAIR OR REPLACE THE RACK FREE OF CHARGE.

**R. A. ALLEN Co., Inc.**  
**505 BEACHLAND BLVD.—SUITE 5**  
**VERO BEACH, FL 32963**  
**(800) 722-5536**  
**FAX: (772) 234-5796**

**WWW.ALLENRACKS.COM - CUSTOMERSERVICE@ALLENRACKS.COM**